

LED SERIES LIGHTHEADS



RECT-34L Series

3" x 4" LED Rectangular Lamps

The RECT-34L LED lamp family features ultra-high intensity LED's and has a new optical wide angle lens. The lamps are designed for 12-28 VDC operation and have potted electronics for the ultimate in reliability. Expected life is 100,000 hours. Warranty is five years from date of purchase. The lamps come complete with mounting hardware, WP connector with 12" leads or integrated 12" leads. The RECT-34L series is designed to fit any TOMAR 3" x 4" mounting bezel. Meets SAE J845 and SAE J1889.

- ultra-high intensity LED's
- wide angle optical lens
- fits all popular emergency vehicles
- five year warranty
- available in five lens colors



Amber



Blue



Clear



Green



Red

Ordering Information







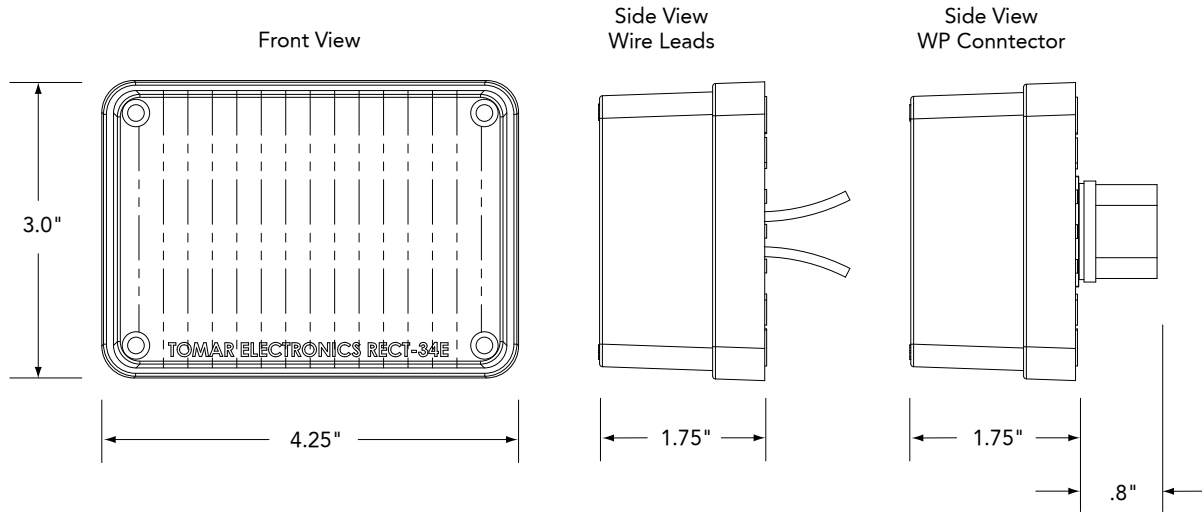

Please specify lens colors and model number when ordering. Available colors are Amber, Blue, Clear, Green and Red.

Model No.	Description
RECT-34L	LED, 3" x 4" rectangular lamp, clear lens, WP connector
RECT-34CL	LED, 3" x 4" rectangular lamp, colored lens, WP connector
RECT-34LW	LED, 3" x 4" rectangular lamp, clear lens, wire leads (no connector)
RECT-34CLW	LED, 3" x 4" rectangular lamp, colored lens, wire leads (no connector)

RECT-34L SERIES LIGHTHEADS



RECT-34L Lamp Configurations and Available Colors

WP Connector	Wire Leads	Color
CL	CLW	 A  B  G  R
L	LW	 B  B  G  R  W

Ordering Example

RECT - 34 - LW - R

34 - 3" x 4" rectangular lamp	See available colors above
L Clear lens, single LED color	CL Color lens, single LED color
LW Clear lens, single LED color	CLW Color lens, single LED color

Specifications

Item	Description
Voltage	10 thru 30VDC
Current Draw	0.45A @ 12VDC 0.225A @ 28VDC
Warranty	Extended 5 year warranty

See page C32-C33 for a complete list of available mounting accessories.